

FOR AVERAGE HOME GARDEN

FOR AVERAGE GARDEN & SURPLUS FOR SALE

HOT BEDS LARGER THAN 6'X6' SHOULD BE BUILT 6' WIDE AND MULTIPLES OF 3' IN LENGTH

LOCATION-A SUNNY SOUTHERN EXPOSURE IN A WELL DRAINED LOCATION IS NEEDED. SOME WINDBREAK PROTECTION ON NORTH IS DESIRABLE.

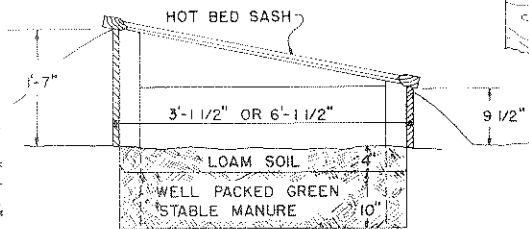
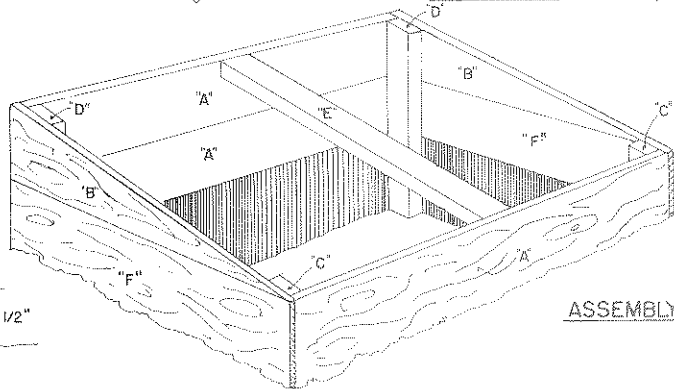
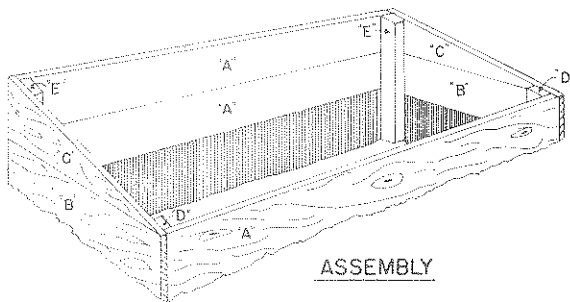
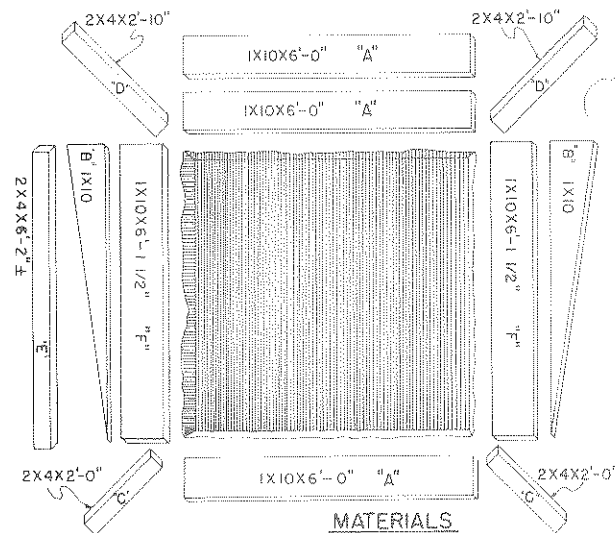
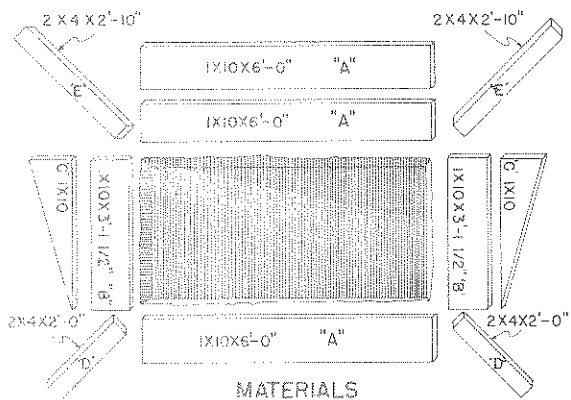
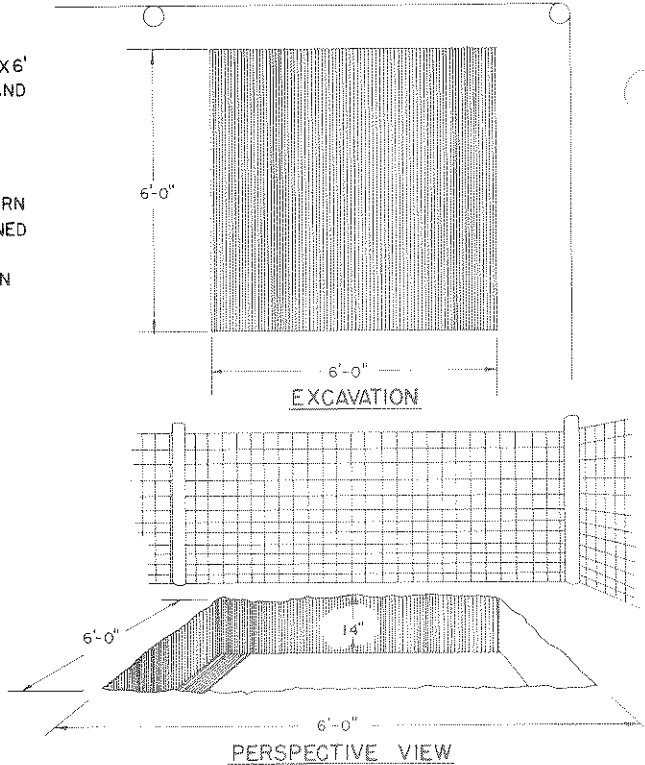
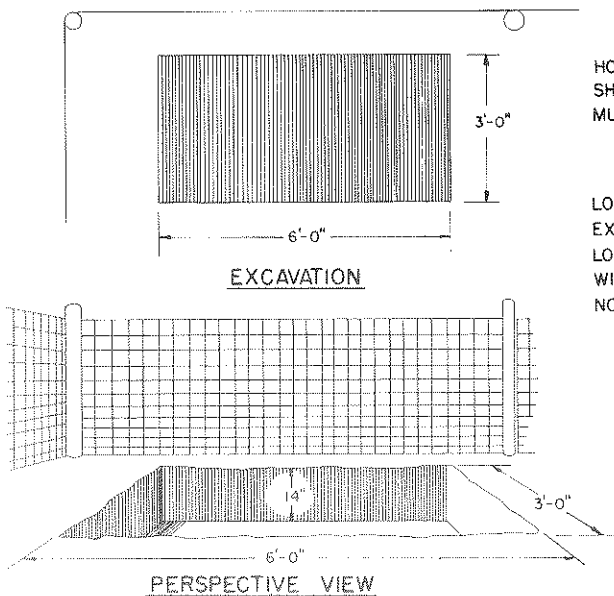

TYPICAL CROSS SECTION

NOTE: THE SASH COVER CAN BE MADE OF ONE OF SEVERAL MATERIALS. THE STANDARD GLASS HOT BED SASH IS 3'X6' IN SIZE. IT REPRESENTS THE IDEAL COVER-LASTING MANY YEARS. IT IS SOMEWHAT EXPENSIVE, IF OLD DISCARDED WINDOW SASH ARE AVAILABLE, USE THEM. BUILD FRAME TO FIT SASH. INEXPENSIVE COVERS CAN BE MADE WITH 4 OR 6 MIL. PLASTIC TACKED ON A LIGHT HOMEMADE FRAME, IT CAN BE MADE IN MANY DIFFERENT SIZES. THIS IS SATISFACTORY FROM STANDPOINT OF LIGHT, BUT IS SHORT LIVED, USUALLY TWO SEASONS.

BASED ON MISS. STATE UNIV. PLAN 8080-A

COOPERATIVE EXTENSION WORK IN AGRICULTURE AND HOME ECONOMICS	
UNIVERSITY OF MISSISSIPPI DEPARTMENT OF AGRICULTURE COOPERATING	
AND MISS. STATE UNIV.	
HOT-BED	
MISS. '74	6206
SHEET 1 OF 2	

CONNECT SERVICE CABLE TO A WEATHERTIGHT SERVICE SWITCH ON POLE PROPERLY FUSED & GROUNDED

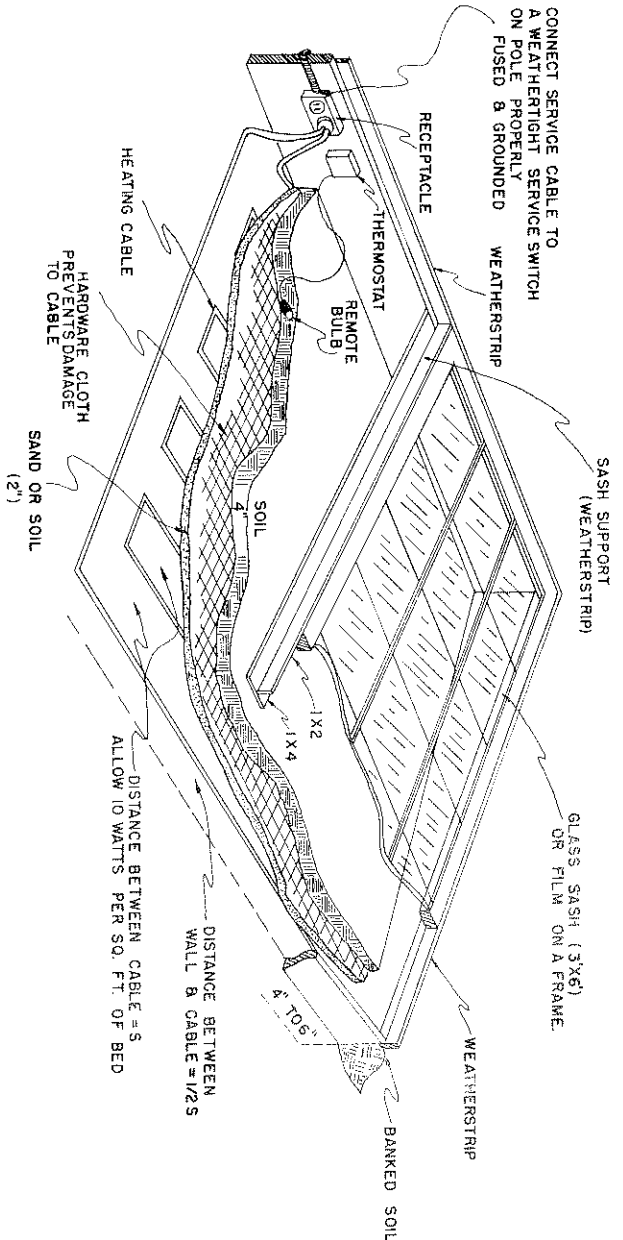

CONSTRUCTION CUTAWAY

COVERING

GLASS SASH IS THE BEST TYPE OF COVERING FOR HOTBEDS, BUT IT IS ALSO THE MOST EXPENSIVE. OTHER MATERIAL, SUCH AS PLASTIC-COATED FABRIC, OR TREATED MUSLIN, PROVIDES A SATISFACTORY COVERING.

HEATING CABLE

BOTH LEAD-COVERED AND PLASTIC-COVERED CABLE GIVE SATISFACTORY RESULTS, WHEN USED PROPERLY. IN SOUTHERN AREAS 10 WATTS PER SQ. FOOT HAVE PROVED ADEQUATE. YOUR POWER SUPPLIER OR QUALIFIED DEALER CAN ASSIST YOU IN SELECTING HEATING CABLE. LAY THE CABLE ON THE SOIL AT THE BOTTOM OF THE BED, OR IF THE BED WAS EXCAVATED, LAY IT ON THE SAND THAT WAS SPREAD ON THE GUNDERS OR GRAVEL. THE SPACING BETWEEN LOOPS OR SECTIONS OF THE CABLE IS IMPORTANT. THE FORMULA FOR THIS IS AS FOLLOWS --

$$\text{SPACING (IN INCHES)} = \frac{12 \times \text{WATTS PER FOOT OF CABLE}}{\text{WATTAGE REQUIRED PER SQ. FT. OF BED}}$$

THE SPACING BETWEEN THE OUTSIDE CABLE AND THE WALL IS HALF THE SPACING BETWEEN CABLE.

MAKE ALL CONNECTIONS TO THE HEATING CABLE WATERTIGHT TO EXCLUDE MOISTURE. THE WIRING SHOULD CONFORM TO THE NATIONAL ELECTRICAL CODE AND TO THE REQUIREMENTS OF THE LOCAL POWER SUPPLIER. IT SHOULD BE INSTALLED BY A REPRESENTATIVE OF THE POWER SUPPLIER OR BY A QUALIFIED ELECTRICIAN.

CONNECT A THERMOSTAT WITH AN OPERATING RANGE OF 30° TO 120°F (15° F DIFFERENTIAL) IN THE ELECTRIC CIRCUIT TO CONTROL THE TEMPERATURE IN THE BED. THE THERMOSTAT MUST HAVE SUFFICIENT CURRENT-CARRYING CAPACITY TO HANDLE THE BED OR SECTION OF BED THAT IT CONTROLS. DO NOT PLACE THE THERMOSTAT OR BULB DIRECTLY ABOVE A HEATING CABLE OR ALLOW IT TO COME IN CONTACT WITH A CABLE.

PRECAUTIONS

OBSERVE THESE PRECAUTIONS WHEN PLACING THE CABLE:
LAY THE CABLE IN POSITION CAREFULLY TO AVOID DAMAGING THE SHEATH OR CONDUCTOR. KINKS MAY DAMAGE OR BREAK THE CABLE. DO NOT CROSS ONE CABLE OR SECTION OF CABLE OVER ANOTHER. DO NOT SHORTEN THE LENGTH OF A CABLE. A SHORTENED CABLE MAY BECOME TOO HOT AND BURN OUT.

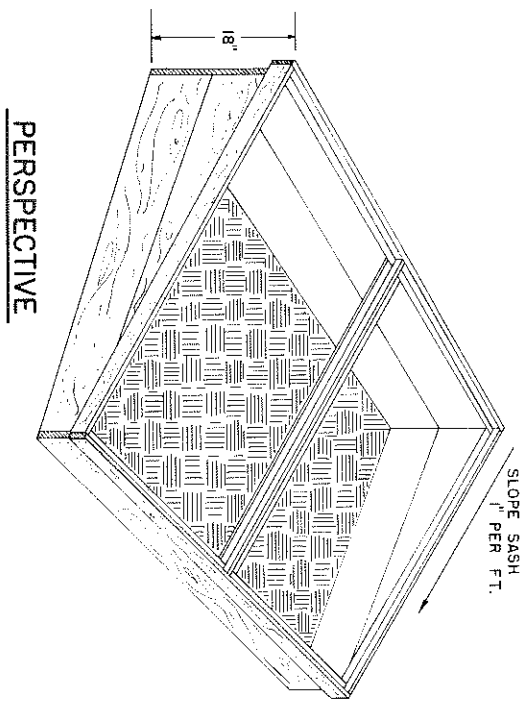

PERSPECTIVE

COOPERATIVE EXTENSION WORK IN AGRICULTURE AND HOME ECONOMICS

AND UNITED STATES DEPARTMENT OF AGRICULTURE COOPERATING

MISS. '74 6206 SHEET 2 OF 2